

stereo shop

audio/video interiors

TALK

Newsletter of The Stereo Shop, Inc. • 505 Farmington Ave., Hartford, CT 06105 • 860/523-7250 • Holiday 2004/2005

Seasons Greetings

The Stereo Shop provides you with the best sounding equipment and the most professional service

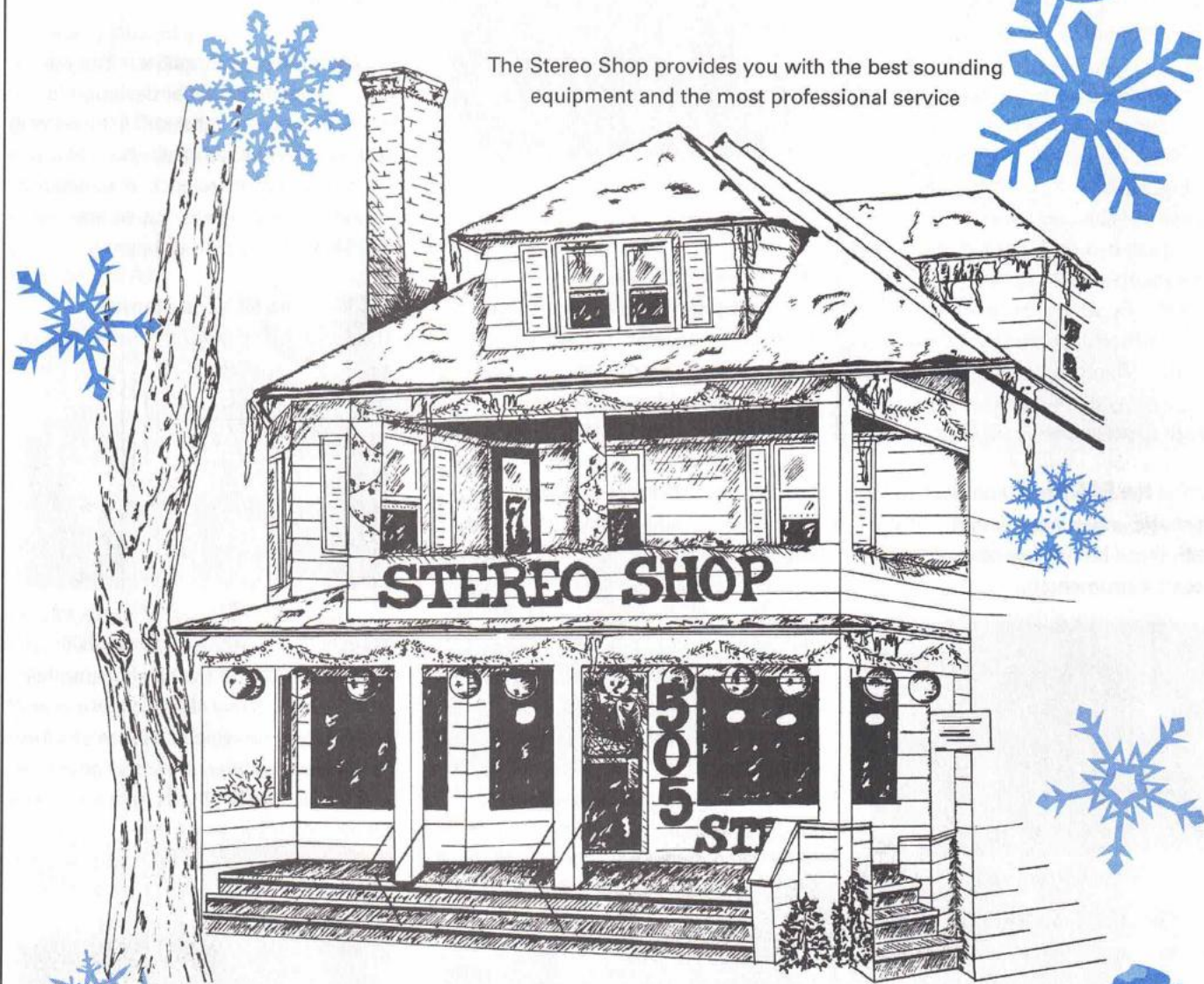

Celebrating 46 Years since 1959!

What was true then is true today:

QUALITY KNOWLEDGE EXPERIENCE



Visit us on the World Wide Web at www.thestereoshop.com

McIntosh Laboratory

McIntosh instruments have always been designed for long life, with low maintenance costs and highest-quality performance. McIntosh instruments have always been, and are, the laboratory standard for the world. PowerGuard protects your McIntosh amplifier from any harsh, unpleasant distortion due to amplifier overload that decreases your musical pleasure and enjoyment. Digitally-controlled electromagnetic switch contacts, isolated from environmental contamination inside inert gas-filled tubes, provide the most reliable, quietest and lowest distortion switching possible. The famous glowing blue wattmeters keep you informed of the power quantity you are using. And, most important, the sound of each component is superb. It's no wonder that for over 56 years, satisfied customers the world over view their McIntosh products as investments worthy of being passed down through generations.

NEW – the BEST in home theater!

Bring music and movies to wonderful life with these brand-new magnificent McIntosh instruments!



MX-135 home theater controller

NEW! MX135 Home Theater

Controller – A brilliant idea and engineering marvel – a component that will delight the two-channel stereophonic music lover as well as the uncompromising, digital home theater enthusiast! Five sets of component video inputs, along with composite and S-Video upconversion combine for unparalleled video connectivity! Included is the fastest and most advanced digital signal processing in all the latest modes. Also, for audio-

phile music reproduction, enjoy two-channel stereo analog functionality, with high-performance phono input. An additional input is provided for the optional dealer-installed TM-1 Phase-Locked Loop AM/FM Tuner Module. Stunningly beautiful, with back-lit controls and McIntosh's timeless glass front panel.

\$7,600.00



MX-119 home theater controller

Hot off the Press!

MX-119 Home Theater controller –

McIntosh's newest preamp / processor, the MX119 has been designed for those who won't compromise performance but don't need the immense rear panel connectivity of the MX135. **\$4,995.00**

NEW! MVP-861 DVD/CD Player

– What an incredible playback source for your movies and music! The MVD861 is a universal player with built-in SACD, DVD Audio, Dolby Digital and DTS Decoder. Three 192kHz/24-bit PCM/DSD stereo DACs provide superior high fidelity sound. Video features include progressive scan and the choice of NTSC or PAL video output. The player utilizes 12-bit high-speed video DAC where video processing is performed at a rapid rate, minimizing digital artifacts for enhanced DVD picture quality. **\$4,100.00**

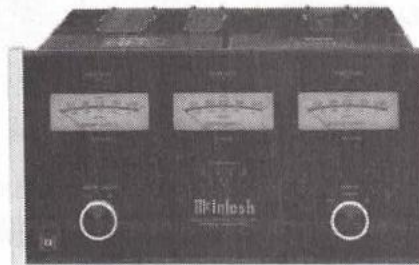

MC-207 seven-channel

NEW! MC207 7-channel Amplifier –

Designed for use in a 7.1 home theater or

in a 5.1 home theater with the remaining two channels available for a second stereo zone. You will get ALL the power you paid for because this is the first amplifier with DYNAMIC POWER MANAGER (DPM), a unique McIntosh circuit that allows the MC207 to deliver a full 200 watts per channel into either 4 or 8 ohm loudspeakers with almost immeasurable distortion and cool operation.

\$5,995.00

MC206 6-channel Amplifier – The perfect audiophile amplifier designed for today's surround enhanced 6.1 theater systems. The MC206 delivers a minimum of 200 watts to each of six channels at 4 ohms, with plenty in reserve.

\$4,599.00

NEW – the BEST in stereo!

Thrill to the splendor of music as it was meant to be heard!



MA-6900 integrated amplifier

MA6900 integrated amplifier – With all the great sound of McIntosh separates on one easy to use chassis, there is a preamp section which includes electromagnetic switching, a graphic equalizer and inputs for CD, video, tape and – yes, phono! With 200 watts per channel, this is the perfect upgrade for those old separates! **\$4,599.00**



MA-6500 integrated amplifier

MA6500 integrated amplifier - All the premium features you dream of in a convenient integrated amp! An excellent audiophile design, with 6 inputs,

including phono, 120 watts per channel and PowerGuard. Perfect for compact spaces where versatility is a premium! **\$3,099.00**



C45 audio control center

C45 audio control center – This preamp is designed for the music lover. Included is a high-performance phono input, and dual 6-channel inputs for the latest multi-channel digital audio formats, including DVD-Audio, SACD, Dolby Digital and DTS Audio/Video. Perfectly mated to any of our legendary McIntosh power amplifiers! **\$3,599.00**

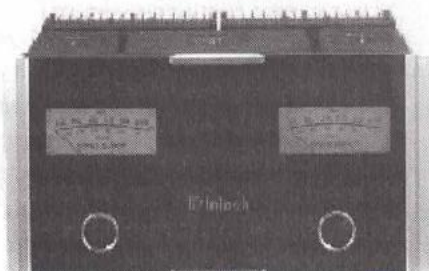

MC-252 power amplifier

MC252 stereo power amplifier – An instant classic with 250 watts per channel, perfect for most home stereo needs! With ultra-low distortion and includes all the McIntosh technologies famous for protecting both amp and speakers under any conditions. **\$3,795.00**

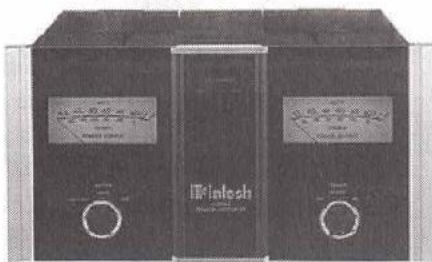

MC-402 stereo power amplifier

MC402 stereo power amplifier – Enjoy absolute musical transparency and accuracy combined with super high power reserves – over 400 watts per channel into loads of 2, 4 or 8 ohms! **\$5,100.00**

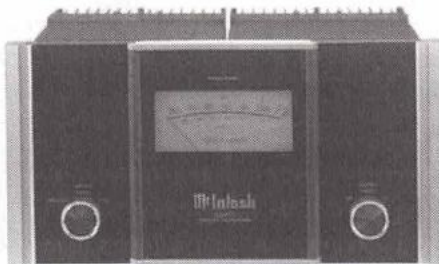

MC-501 mono-block amplifier

MC501 mono-block power amplifier – With distortion of no more than 0.005% and 500 watts (over 1200 watts of peak power!), this monaural (one channel) amp's new quad-differential design reduces noise and distortion to record low levels! Just the thing for those who require maximum performance! **\$4,100.00**

NEW – Back to the Future - the BEST in vacuum tube performance!

Famous for the finest tube equipment ever made, McIntosh re-introduces the harmony of tube amplification for a new generation: the warmth and musicality of tubes meets the latest technology.

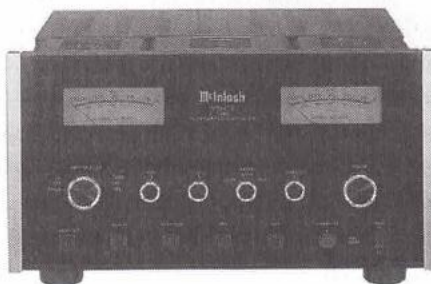

MA-2275 tube integrated amplifier

MA2275 tube integrated amplifier – Make this the prized centerpiece of your private listening room! Producing a minimum of 75 watts per channel, this superb new design combines classic McIntosh vacuum tube performance with state-of-the-art control circuitry. Includes a built-in low noise moving magnet phono input, a set of XLR jacks for a balanced input, 6 sets of

unbalanced inputs, preamp out/amplifier in loop, and an extra set of pre-outs! **\$6,100.00**

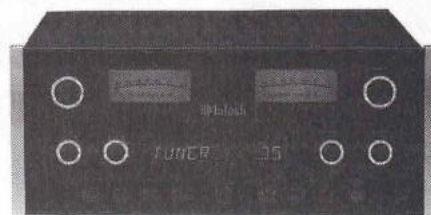

C-2200 tube preamplifier

C2200 tube preamplifier – Make the music magic, the way you always dreamed of! This beautifully-finished 21st century preamplifier features all the latest McIntosh control technologies coupled with the venerable tube tradition that made McIntosh famous! Exult in the lush sound of this remarkable instrument, perfect in combination with McIntosh transistor or tube power amplifiers. **\$4,600.00**

MC275 tube power amplifier – For generations since the early 1960s, this most sought-after but rare amplifier with heavenly sound has been upheld as the icon of McIntosh tube genius. Now, finally, you can acquire a high-tech update of McIntosh's most famous tube amplifier – including balanced and unbalanced inputs, new detachable power cable and power switch. With 75 watts per channel, the MC275 is STILL the unsurpassed masterpiece of McIntosh tube innovation! **\$3,495.00**

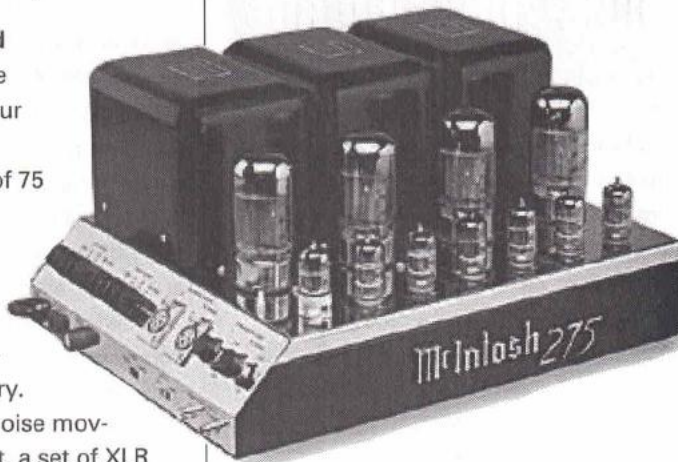

MC-275 tube power amplifier

Bowers and Wilkins of England offer the most beautiful, refined and best-performing speakers at every level of application, from house-shaking home theater to all the subtle details in music. You might say that they are probably the best speaker makers in the world! Indeed, due to their unparalleled capabilities, B&W speakers are used as the monitors of choice in over 80 percent of the world's recording studios, and also for movie soundtrack mix-downs! Not only do these speakers sound wonderful, but they are superbly designed and crafted, and look great in any decor! Not surprisingly, from \$300.00 to over \$11,000 per pair, each B&W speaker system is designed and built with the same goal in mind – to provide you the sound, design and craftsmanship you deserve – the finest!

B&W Technology

How can B&W speakers be made to sound so transparent, so natural – in effect, to "disappear", leaving only the actual music to be savored? B&W research and development found that certain cabinet designs, driver design and materials were essential to create transparent speakers. They engineered internal cabinet brace and sound flow configurations, coupled with driver materials like Kevlar and cobex, for unrivalled clarity. Most recently, they devised a new speaker design, resembling a gigantic nautilus shellfish. From this extremely expensive and limited edition design, they utilize for all their speakers elements of this famed "Nautilus" technology: notably,



N802

extensive tubing applied to the rear of drivers to draw away unwanted radiation from the rear of the driver diaphragm, resulting in more natural, focused sound. In fact, every B&W tweeter uses the Nautilus technology for the most accurate high frequency response.

New from B&W

The Stereo Shop has always been known for having the remarkable Bowers and Wilkins speaker line from England, perhaps the best speakers on the market today. And now we introduce their newest line of speakers, each level incorporating much of their famed cabinet, driver and "Nautilus" technology used to eliminate coloration, leaving pure, clear music as it was meant to be heard!

Nautilus 800 Series

B&W's best loudspeakers offer highest performance at every level. Every driver employs Nautilus tubing, and each cabinet uses the multiple-cell "honeycomb" Matrix enclosure. The result is a line of speakers that are the closest yet to musical perfection! For example, the Nautilus 802 utilizes two 8-inch bass drivers in a fairly narrow cabinet. This allows the speaker to sit comfortably in many domestic surroundings, yet there is no compromise in performance. It has received excellent reviews from the "hi-fi" press for both aesthetics and sound quality – including the heart-stopping bass response! This speaker series has



N804

earned B&W such accolades as "best in the world," and they certainly are the best in the world at their comparatively modest price points!

The series features a variety of models from the most highly developed floor-stander to the compact Nautilus 805. There are also Home Theatre center channels (HTM1 and HTM2), a surround speaker (SCM1) and subwoofers (ASW800 and ASW850)! The speakers come in a choice of Black Ash, Cherrywood and Red Stained Cherrywood real wood veneer finishes. The N803 and N804 are floor standing speakers, beautifully styled, with nearly all the performance of the flagship speakers. The N805 is a small monitor speaker that fits elegantly into any room. Come and audition the finest speakers from B&W!

N802 \$3995.00ea **N803 \$2495.00ea**
N804 \$1749.00ea **N805 \$995.00ea**



N805

NEW! 700 Series

This brand-new premium speaker series provides superb craftsmanship and technology in both audio and Home Theater applications. Its cabinet is designed to reduce unwanted internal resonance and its new surroundless Kevlar midrange provides superior smoothness and transparency. Setting a new standard for this premium sector in both performance and design, the 700 Series comprises seven speaker models for both audio and Home Theatre applications. The choice starts with two floor-standing models (703 and 704) and one stand-mount bookshelf model (705) for main speaker duty. For home theater applications, the center (HTM7) and rear surround (DS7) speakers and two formidable subwoofers (ASW700 and ASW750) complete the line-up.

All models, with the exception of the DS7, are available in a choice of five real wood veneers - Maple, Cherry, Rosenut, Walnut and Black Ash - with main and center models featuring curved one-piece top and front panels. The DS7 comes in a choice of black or white painted finishes. **703 \$1,495.00ea**
704 \$1,099.00ea **705 \$749.00ea**

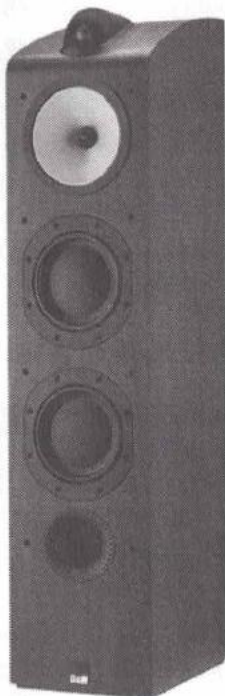

703

600 Series 3

The most popular B&W speaker line-up is the easily affordable 600 Series 3, with the patented Kevlar midrange/bass driver. From bookshelves to floor standing towers, the new 600's are more transparent than ever! Midrange/bass drivers feature well-proven Kevlar cones while

bass drivers benefit from rigid aluminum. Tweeters have improved ultrasonic performance and feature Nautilus tube loading for clarity and openness. Finished in Black Ash or Sorrento Oak.

DM 600 S3

A very compact bookshelf speaker with 5 inch woofer **\$175.00ea**

DM 601 S3

A compact bookshelf speaker, with 6 _ inch woofer **\$225.00ea**

DM 602 S3

Bookshelf size, but with a larger 7 inch woofer **\$295.00ea**

DM 603 S3

A small tower, with two 6.5 inch drivers **\$495.00ea**

DM 604 S3

A tower system with two 7 inch bass drivers, and Kevlarbass/midrange. **\$695.00ea**

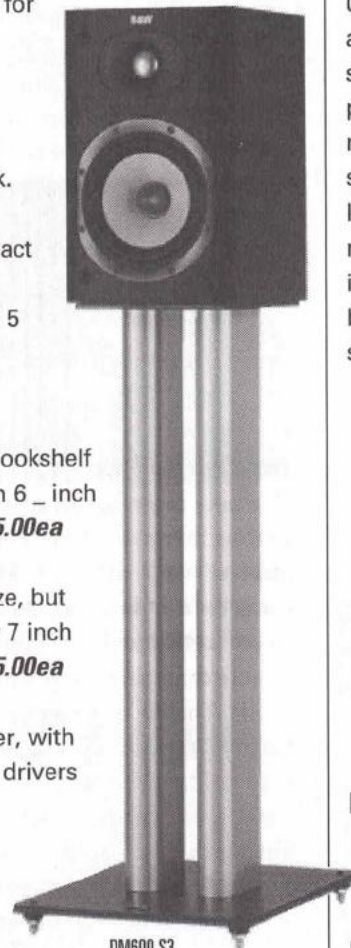

DM600 S3

Also available for Home Theater are matching **center channel speaker** models (**LCR60 S3** and **LCR600 S3**), **rear surround speakers** (**DS6 S3** and **CDS6 S3**) and **subwoofers** (**ASW600**, **ASW650** and **ASW675**). This provides tremendous design flexibility and affordability in Home Theater systems. **LCR-60S3 \$349.00ea**
LCR-600S3 \$496.00ea

B&W DM 303

The most affordable B&W speaker! This small bookshelf system may seem typical, but it is one of the finest small speakers available. It employs the Nautilus tweeter, and its cabinet technology includes dimpled surfaces for opti-

mum sound wave flow. The DM303 can be used in nearly any system, small or large, providing rewarding sound and endless hours of musical enjoyment. Listen to music as it was meant to be heard, with this beautifully made and affordable small speaker! **\$149.00ea**



B&W Subwoofers

— for the love of music

Finally, subwoofers that sound like music, not booming thumps. With new cabinet and driver designs that reproduce the true satisfying, natural bass in your music. **Starting at \$350.00**

Architectural Series

B&W now has the capability of giving you the same great sound installed in your walls! From the smallest two-way system to concert-hall performance systems, we will work with you and your architect to design a custom system that blends with your lifestyle. **Starting at \$149.00ea**



Yamaha, the world's largest producer of musical instruments, also makes some of the best audio components. In the digital age, Yamaha is a pioneer of Digital Sound Field Processing, allowing immense flexibility in creating sound environments for home theater applications. All of their acoustic and audio expertise is now engineered into powerful chips that expand and enhance your entertainment possibilities. The heft and feel of every Yamaha component is testimony to their superior build quality and attention to detail.

Home Theater Receivers

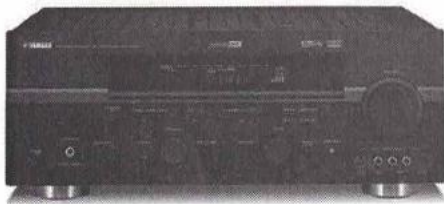

RX-V650

Yamaha RX-V650

An extremely affordable 7.1-channel, 665 watt (95W x 7) receiver with Digital ToP-ART and high current amplification. Compatible with all the latest movie sound formats including Dolby Digital and Dolby Pro Logic IIx. Its ultra-easy set-up uses a microphone and built-in analyzer to measure and compute the perfect set-up parameters for your room to provide you with the most amazing sound (YPAO - Yamaha Parametric Room Optimizer) for automatically adjusting the sound in your room. Includes Quad Field CINEMA DSP and 29 surround programs. **\$495.00**

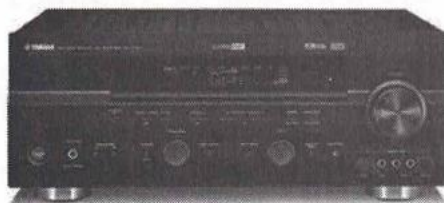

RX-V750

Yamaha RX-V750

A step up from the RX-V650, this great

new 7.1 receiver has 100 watts X 7 channels, Quad Field CINEMA DSP with 51 variations of 29 programs, two-zone capability and many more digital features, including YPAO, component video up-conversion and HDTV compatibility, learning remote. **\$595.00**

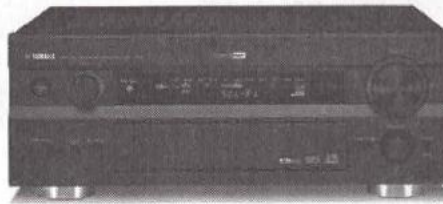

RX-V1500

Yamaha RX-V1500

This new receiver is the entry way into serious home theater! This superior receiver has 7 channels delivering 120 watts each of fabulous surround sound, all controlled with an "intelligent" remote that learns and adapts to your needs. Thanks to a heavier power supply, enjoy a wider sonic stage and great depth of field that puts you in the middle of great entertainment. Major features include up-converting video into component video, and providing audio in a second area. Its incredible floor-to-ceiling and wall-to-wall imaging will astonish you!! Its rich, full sound will delight you! **\$795.00**

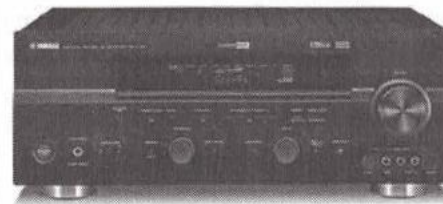

RX-V2500

Yamaha RX-V2500

For those who want a little extra, this beautifully-designed next step up receiver has all the great features of the RX-V1500, plus more power, more flexibility and a more versatile remote control. With 910 watts (130 watts x 7) and a user-friendly graphic interface. **\$995.00**

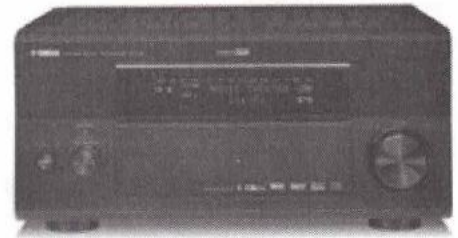

RX-Z9

Yamaha RX-Z9

— the ultimate home theater receiver

Imagine a 9.1 channel, 1,290 watt surround sound receiver with a selection of 51 sound programs with 71 variations! Add an automatic parametric room acoustic optimizer to analyze room acoustics and optimize sound output to match. This is the best sounding, most satisfying home theater receiver Yamaha has ever made. Perfect for custom installations. Please come in for a demonstration of its tremendous and unmatched capability! **\$4495.00**

DVD Players



DVD C-750

NEW! DVD C-750 5-disc DVD changer

- Yamaha's best! Features progressive scan video circuit along with 3:2 pull-down for higher resolution and better color. Finest audio/video reproduction with SACD playback, DVD Audio and Faroudja processing for smooth and natural images. Burr-Brown DAC for precise audio reproduction with dual laser pickup. **\$299.00**



DVD C-6760

DVD C-6760 5-disc DVD changer -

Wonderful flexibility for movies and music! A superb quality player with progressive scan video output and Burr-Brown DACs. SACD, MP3 and CD-R/RW playback compatibility too! **\$199.00**

Yamaha Stereo Receivers

Each is built to be the best in its class, with high quality parts and excellent sound.

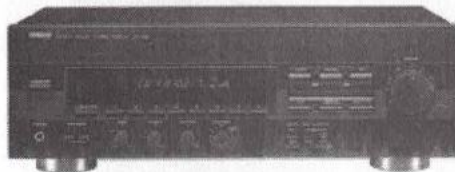

RX-396

RX-396

50 watts per channel, 5 audio inputs, 1 tape monitor. **\$295.00**

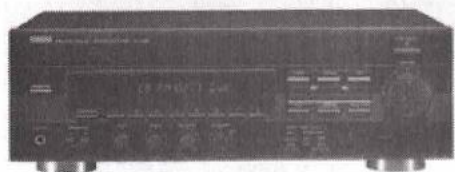

RX-496

RX-496

75 watts per channel, 6 audio inputs including 2 tape monitors. **\$349.00**



RX-396

RX-596

80 watts per channel, 4 audio and 2 video inputs. **\$449.00**

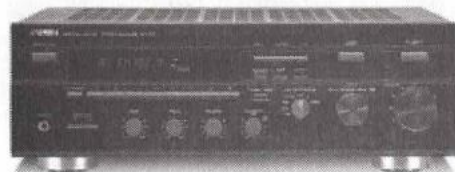

RX-777

RX-777

100 watts per channel. This is a great audiophile receiver! Zone 2 out for custom installations. **\$599.00**

New from YAMAHA



DVD-S550
\$149.00



DVD-S1500
\$399.00

CD Changer

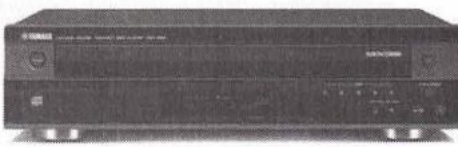

CD C-585

CDC-585 5-disc changer - Load up five CDs and you've got half a day's entertainment! High quality, exciting sound and top-notch convenience at a good price make this a bargain! **\$149.00**



CD C-685

CDC-685 5 disc changer - Yamaha's best sounding CD changer, with text display, variable output control and digital output. **\$229.00**

digital audio terminal (also known as a "client receiver"). Store your family's music on the server's hard drive, and access it all with an on-screen display for artist, album, genre or song. Program any mix you wish. Think of the server as a CD player/recorder that can also broadcast to other rooms of your house. The server can play up to eight music programs simultaneously, "music casting" a program to client receivers in up to seven other locations. You may also select your music programs from any client location, making it unnecessary to visit the main server. If you wish, you can even record custom CDs on the server. This amazing innovation will change the way you record, select and listen to music! Come in for an awesome demonstration today!

MCX-1000 \$2195.00

MCX-A10 \$595.00



MCX-1000

Yamaha MusicCast - World's First Multi-Room Wireless Music Network

Yamaha has the ultimate CD changer/recorder! Store 1,000 CD's on its hard drive, copy CDs, create your own music compilations, or broadcast music all over your house! Yamaha provides the means with the new **MCX-1000 digital audio server** and **MCX-A10**

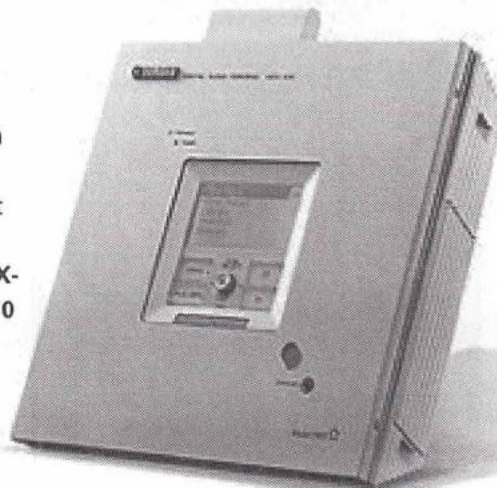

MCX-A10

NEW! FUJITSU Plasmavision Plasma TV Monitors

Fujitsu's new line of Plasmavision monitors feature an upgraded version of the acclaimed AVM digital video processor, the Advanced Video Movement-II (AVM-II) processor, an HDMI input and a stunning new cabinet design.

Fujitsu's latest Plasmavision monitors provide the ultimate viewing experience. A sleek and lightweight design allow these monitors to be hung on a wall or placed on a stand to seamlessly integrate into any home theater system. Superior picture quality and natural color display combine with a resolution to transport you to far away places. Whether you're watching a sporting event or your favorite television program, images look so real you'll feel like you're actually there.



Fujitsu P50HHA40US – 50" high definition plasma TV monitor **\$8,999.00**

Fujitsu P42HHA40US – 42" high definition plasma TV monitor **\$6,999.00**

Fujitsu P42VHA40US – 42" extended definition TV monitor **\$4,999.00**

All Fujitsu monitors come with three years free parts and labor!

MITSUBISHI — LCD TV and DLP Technology

NEW! Mitsubishi's LCD TVs are flat panel in a small size. The future of TV is here now and extremely affordable! With two sizes now available - 22" and 30"! They include built-in tuners and speakers. Hang one on a wall or put it on a table top! Perfect for smaller rooms like dens and bedrooms!



Mitsubishi LT-2240 22" LCD TV **\$2,495.00**
Mitsubishi LT-3040 30" LCD TV **\$3,995.00**

NEW! MITSUBISHI BIG SCREEN TVs

The new Mitsubishi Big Screen TVs are in, and are easily placed anywhere in your home, thanks to Digital Light Processing (DLP) technology. The Mitsubishi Diamond and Medallion series DLP TVs are available in 62" or 52" widescreen formats. These MicroDisplay Integrated Digital Cable Ready HDTVs present stunningly brilliant and lifelike picture – all in a slim, compact cabinet!

Diamond 825 Series – Beyond the brilliant picture and sound quality, this top-of-the-line Mitsubishi model offers revolutionary programming control and recording capabilities – all in a sleek, stylish design. A complete viewing experience, this impressive model offers intelligent features like a 120GB PVR hard-drive that records 12 hours of HD programming or 72 hours of standard TV with instant replay and pause functions.

Diamond WD-52825 **\$5,499.00**
Diamond WD-62825 - **\$5,999.00**

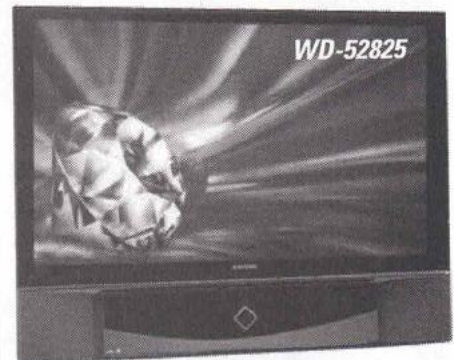

Medallion 725 Series - Perhaps the most amazing feature of this remarkable television is that such brilliant colors and clarity come from such a thin, clean form. With features including the Mitsubishi 1280X720p Proprietary DLP Light Engine, you'll enjoy images that set new, higher standards for brightness, resolution and clarity.

Medallion WD 52725 **\$3,699.00**
Medallion WD 62725 **\$4,499.00**

DO YOU WANT 0 DOWN, 0 PAYMENTS, 0 INTEREST FOR A YEAR? YOU GOT IT WITH MITSUBISHI!

Salamander Furniture

The Stereo Shop not only sells beautiful audio/video equipment, but also offers the proper furniture to display them. Salamander Designs is an innovative furniture systems company dedicated to integrating your electronics with your living space. They named their contemporary flagship furniture series Synergy System because it relies on shared energy and lets you link your ideas with theirs. The system concept is elegant simplicity combined with remarkable versatility. They are strong, they look great, and they are made for audio and video components.

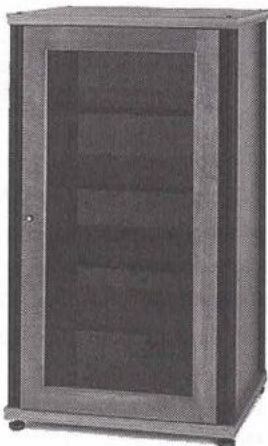

Finishes include cherry, maple and walnut as well as black. You can select side panels in matching hardwood or choose either perforated steel or ultrasuede-covered panels for cabinet sides. Corner posts come in matte black or satin aluminum.



Come in and see several popular configurations on display. Your system looks great on Salamander Design furniture!



CONRAD JOHNSON — It just sounds right.

The reputation of **Conrad-Johnson** components and systems in the audiophile community is their unmatched ability to convey the emotional content of the musical experience. These are award-winning designs with many rave reviews in the high fidelity press. Year after year Conrad-Johnson products are listed as "best in class" in various categories by the most prestigious publications. Their claim to fame is their marvelous, reliable tube and transistor preamplifiers and power amplifiers, which sound absolutely glorious!

solid state designs. There is a euphonious, emotional involvement with reproduced music that many enthusiasts seek and only find with the highest quality tube components. The Premiere 17 LS preamplifier is the finest example of this, and as such is the centerpiece of a two-channel music system whose purpose is to emotionally involve the listener completely in the musical experience. This preamplifier can completely transform any music system into something finer, bringing a depth and breadth to the listening experience that was missing before. This is a transcendent musical



Premiere 140

and other audiophiles who require near perfection from their reference systems! The latest in the highly-regarded Premiere series of vacuum-tube power amplifiers, the Premiere 140 is the proverbial iron hand in a velvet glove – capturing delicate textures and subtle nuances while demonstrating muscular power, authority and control. Redefine your expectations with the highest level of quality in tube amplification. With 140 watts per channel, this stereo amplifier sets the standard of performance in the lucid and true-to-life presentation of music. **\$6,795.00**

instrument! **\$4,495.00**

Tube Power Amplifiers

Premier 140 - This is a music reproduction instrument designed to meet the needs of audio industry professionals



Premiere 17 LS-2

Tube Preamplifier

Premiere 17 LS-2 – Tube instruments traditionally have been perceived as having an elusive, musical quality absent in

The Stereo Shop is pleased to feature advanced components by Rotel, one of the world's great electronics firms. For over 40 years, **ROTEL** has been a family owned company dedicated to the design and manufacture of the finest in affordable, high performance home theater and high fidelity components. Rotel products delight exacting audiophiles with their stellar build quality and are beautifully engineered. Their Balanced Design Concept is a disciplined synthesis of physics, electronics and mechanical engineering guided by a firm belief that the best method need not be the most costly. This approach guarantees that only those designs and parts which do best become Rotel components – and only after they have passed all tests made with the ultimate laboratory instrument – the human ear.

ROTEL audio/videophile Home Theater components

– PICTURE PERFECT SURROUND SPECTACULAR!



RSP-1098

RSP-1098 preamp/processor – Rotel's flagship control center handles all the components of your home theater system easily and with grace. Its clutter-free front panel features an LCD color monitor, while the rear has room for 8 digital inputs plus 8 analog inputs with composite and S-video capability; and 8 main audio outputs (including 4 digital audio, one tape out, zone 2 out and 3 A/V outputs with composite and S-video connections). It includes all the latest home theater surround sound modes. Enjoy any home theater soundfield program with superb flexibility and outstanding performance. **\$2,999.00**

RSP-1068 preamp/processor - With most of the features of the 1098, this controller



RSP-1068

combines flexibility, superior performance and easy operation. Advanced microprocessors from Crystal Semiconductor handle Dolby Digital, Dolby Digital EX, DTS, and Dolby Pro Logic II decoding. But its most important feature is sound quality. Care in parts selection, circuit design and power supply result in clearly audible superiority. **\$1,699.00**



RMB-1095

RMB-1095 5-channel power amplifier – Producing a full 1,000 watts of power, this is a multi-channel version of a Rotel amplifier design recognized as among the finest at any price. The power supply is built around two toroidal transformers. A sophisticated "over current" protection circuit with front panel LED indicators guards against harmful operating conditions. Rated at 200 watts for each of 5 channels, this amp provides uncompressed reproduction of the most dynamic source material. **\$1,999.00**

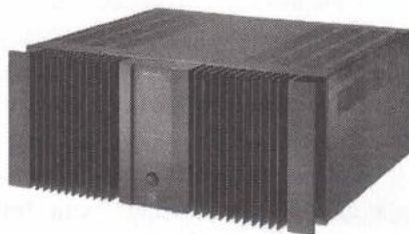

RMB-1075

RMB-1075 5-channel power amplifier – A home theater power amp with a robust 120 watts for each of five channels, its generous headroom and state-of-the-art low signal-to-noise ratio ensure unus-

lied reproduction of the most dynamic as well as the most delicate sonic nuances. Separate 12 volt "trigger" input and output jacks make it well suited for fully integrated systems with total remote control capability. **\$999.00**



RDV-1060

RDV-1060 DVD player – This new progressive scan DVD player is Rotel's best-sounding and most flexible player. It reads DVD-A, DVD-V, CD, CDR, CD-RW, CD-V and MP-3 encoded discs, as well as recordable DVD formats. A high rigidity disc platform means fewer data errors, less correction and better sound quality. Compatible with any whole-home control system. **\$899.00**



RDV-1050

RDV-1050 DVD player – An excellent progressive scan player with a robust power supply for best performance. Critical audio and video D/A converters are all wideband designs usually reserved for players many times its price. **\$699.00**



RDV-1040

RDV-1040 DVD player – A great choice in an audiophile progressive scan player. Its convenient slow search and variable speed scan make it easy to find scenes. You can also adjust for brightness, contrast, tint and other picture parameters. **\$499.00**

ROTEL

ROTEL audiophile stereo components



RB-1090

RB-1090 stereo power amplifier – This amplifier stands as the premier example of Rotel's award-winning prowess in amplifier design. Essentially two amplifiers sharing only a chassis and a power cord, the RB-1090 delivers 380 watts per channel into 8 ohms and a prodigious 700 watts per channel into 4 ohms! The amplifier is stable down to 2 ohms and delivers peak power in excess of 1,500 watts per channel. But even more important than its incredible power reserves is its transparent sound quality – a truly musical component whose function is to reveal all the emotion and majesty of the source material. **\$1,999.00**

ly control diaphragm motion for maximum sound quality. Switchable balanced (XLR) and unbalanced (RCA)

inputs provide extraordinary system configuration flexibility. **\$999.00**

RC-1090 stereo preamplifier – This is the pinnacle of Rotel's dedication to two-channel music reproduction! Circuits for each channel follow Symmetrical Circuit Trace strategy to ensure precise timing, pinpoint imaging, and accurate sound-staging. This magnificent preamplifier boasts 8 inputs, including a low noise MM/MC phono stage and a balanced input with XLR connectors. With separate listen/record controls. **\$1,199.00**



RC-1090

attention to parts and circuitry, high definition CDs (HDCD) are astonishing in their realistic impact. Rotel uses the remarkable new Burr-Brown PCM-1732 IC for advanced digital filtration, HDCD decoding and D/A conversion. A high-density FL display, complete programming capability, remote control and a 12-volt trigger complete the deal! **\$699.00**

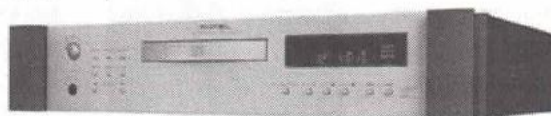

RCD-1072

RCC-1055 CD carousel changer – This is one of the finest changers available, with HDCD decoding and magnificent sound quality. As always, you can be assured of excellent performance and long-life due to Rotel's premium grade parts and superior power supply. **\$699.00**



RX-1052

NEW! RX-1052 stereo receiver – Brand new from Rotel limitless whole house audio. Three zone stereo receiver with tuner. Powerful new amplifier design capable of powering the most demanding speakers. **\$899.00**

RCD-1072 high resolution CD player – If you want a cost-conscious high-performance CD player that outperforms so-called "audiophile"

DVD players, this is an excellent solution. With Rotel's usual meticulous



RCC-1055

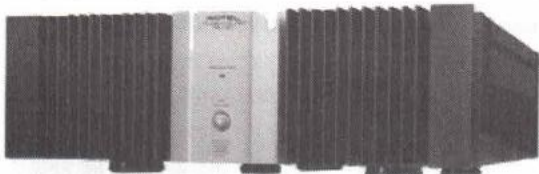

RB-1080

RB-1080 stereo power amplifier – With separate power supplies for each channel, this 200 watt per channel power amplifier is perfect for most audiophile music systems. Damping factor, at 1000, shows how well this amplifier locks on to the most difficult speakers to precise-

Available Exclusively at the
stereo shop
 Arcam, McIntosh,
 Conrad-Johnson, B&W,
 Fujitsu, Runco,
 Definitive Technology,
 Tributaries, Canton
Also on display for your evaluation
 Yamaha, Rotel
 Velodyne, Mitsubishi, Audioquest,
 Ortofon, Grado, SpeakerCraft,
 Salamander

New Generation Powered Towers — with built-in SuperCube powered Subwoofers!

It seems that Definitive speakers just get more and more dramatic. Like, dramatically improved performance in bipolar towers with built-in side-firing powered subwoofers for music and home theater! For big sound so real you are there!

The new Definitive BP7001SC is the most refined example of this technology. This combination of high resolution, magnificent sound-staging, awesome bass and explosive impact envelops you in the ultimate listening experience! The built-in Supercube subwoofers include heavy-duty driver and radiator cones. Built-in amplifiers power the subwoofers, so your receiver or amplifier will only need to handle the midrange and highs. These speakers have an almost magical ability to recreate a stunningly realistic holographic soundfield — plus you can shake the room with dramatic, astounding bass!



BP-7001SC

- BP-7001SC** towers with 10" Supercube subwoofer, 1,500 watt amp **\$1,747.00 ea**
BP-7002 towers with 12" Supercube subwoofer, 300 watt amp **\$1,099.00 ea**
BP-7004 towers with 10" Supercube subwoofer, 300 watt amp **\$799.00 ea**
BP-7006 towers with 8" Supercube sub-

woofer, 300 watt amp **\$599.00 ea**

Powered Centers



C/L/R 2300

The same idea, powered subwoofer in the cabinet, is here in the C/L/R center channel home theater speaker series. These are true, full-range loudspeakers that realize the performance potential of center channel material as the director intended it to be heard. Your movies will be incredibly dramatic as a result!

C/L/R 3000 — with 10" subwoofer, 150-watt amp **\$999.00**

C/L/R 2500 — with 8" subwoofer, 150 watt amp **\$799.00**

C/L/R 2300 — with 6" subwoofer, 150 watt amp **\$599.00**

Rear Surround Speakers

Definitive's line of rear surround speakers include the affordable BP series. These are great bipolar rear channel speakers you can put on the wall or on stands for dramatic surround performance.

BP1.2X specifications

Dimensions: 9-3/16" W x 5-15/16" D x 10-1/2" H Response: 52Hz — 30 kHz. Nominal Impedance: 8 ohms. Power input: 10 — 125 watts. Drivers: Two 12 cm high resolution, high power, bass/midrange drivers with mineral filled polypropylene cones, butyl rubber surrounds and dust caps, and two 25 mm fer-



BP1.2X

rofluid damped moving coil pure aluminum dome tweeters. Finish: Matte black or white. **\$175 ea.**

BP 2X specifications

Dimensions: 9-3/16" W x 5-15/16" D x 14-1/2" H. Response: 45 — 30 kHz. Nominal Impedance: 8 ohms. 13Power input: 10 — 200 watts. Drivers: Two 14 cm high resolution, high power, cast-basket bass-midrange drivers with mineral filled polypropylene cones, butyl rubber surrounds and dust caps, and two 25 mm ferrofluid damped moving coil pure aluminum dome tweeters Finish: Matte black or white. **BP2X \$250.00ea**
BPX \$449.00ea



BPX



PF15TL+ Subwoofer

BASS by Definitive Technology Definitive Subs

Definitive's powered subwoofers deliver ultimate bass performance for your total listening pleasure. You can expect to benefit mightily from high power, high current amplifiers and sophisticated electronic crossovers. The sonic result is accurate, awe-inspiring, high impact, high-reality performance! It is truly a unique combination of delicate musicality and thunderous power for the ultimate in home theater effects as well as unsurpassed musical excellence.

Choose your perfect Definitive powered subwoofer:

PF15TL+ 500 watt powered 15" subwoofer **\$699.00**

Pro Sub 200 TL 250 watt 12" subwoofer **\$549.00**

Pro Sub 100TL 250 watt 10" subwoofer **\$449.00**

Pro Sub 80 250 watt 8" subwoofer **\$349.00**



SuperCube Subwoofer

NEW! SuperCube Subwoofers

This new Definitive line of high-powered subwoofers includes driver and radiator combos with 14", 12" and 8" drivers, with 1,250 watt amplifiers. They have stupendous bass performance and work with any combination of speakers. Slam, pace and rhythm are exemplary as is the ability to actually shake concrete slab foundations! Available in piano-gloss black or golden cherry.

SuperCube I \$1,199.00

SuperCube II \$899.00



Pro center 100

Less is More!

Pro Monitor/Cinema Series

Definitive's ProMonitor 80, 100 and 200 are the ultimate Subwoofer/Satellite systems, with monstrous sound from tiny

speakers that set a new standard for home theater. These magnetically shielded speakers are designed for tremendous



Pro sub 80

placement flexibility and deliver optimum performance when placed either vertically or horizontally in a cabinet or on a bookshelf. A bass/midrange driver and a 1" pure aluminum dome tweeter

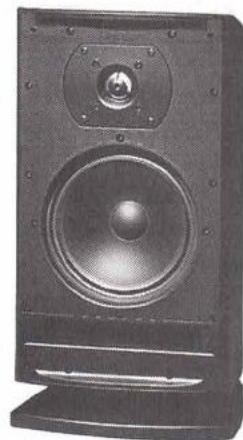

Pro monitor 100

are used to create wide dispersion. Matched with truly superb high-performance subwoofers and center channels, the ProMonitors can be used for music or home theater. Either way, they are

perfect for a dramatic, high-quality system where space is at a premium!

- Pro monitor 80** *\$225.00 pr*
- Pro center 100** *\$199.00*
- Pro sub 80** *\$349.00*
- Pro monitor 100** *\$375.00 pr*
- Pro center C2** *\$299.00*
- Pro sub 100** *\$449.00*
- Pro monitor 200** *\$449.00 pr*
- Pro sub 200** *\$549.00*

Mythos On-wall, Tabletop and Tower Systems

Lovers of elegant interiors, rejoice! Feast your eyes and ears on Mythos, a revolutionary new concept in high-performance, super-refined lifestyle loudspeakers! It begins by answering the need for upscale, on-wall and tabletop loudspeakers to go with plasma TVs. It then proceeds from there to provide a cutting-

edge styling statement tower loudspeaker, which sounds even better than it looks, complements everything and literally redefines the concept of floor-standing loudspeakers!

Definitive offers three Mythos towers in large (**Mythos One**), medium (**Mythos Four**) and small (**Mythos Five**). Place the Mythos towers along side your plasma TV. Or you can hang either of two Mythos front channel models on the wall flanking your TV – a larger (**Mythos Two**) or a smaller (**Mythos Six**). Finally, for Home Theater, you have two choices for a center channel – larger (Mythos Three) or smaller (Mythos Seven). For your rear surround speakers, you can choose any of the Mythos towers or wall speakers. Add a SuperCube subwoofer and you have an elegant, gorgeous and dramatic home theater fashion statement!

- Mythos One** *\$799.00ea*
- Mythos Two** *\$499.00ea*
- Mythos Three** *\$499.00ea*
- Mythos Four** *\$699.00ea*
- Mythos Five** *\$499.00ea*
- Mythos Six** *\$349.00ea*
- Mythos Seven** *\$349.00ea*

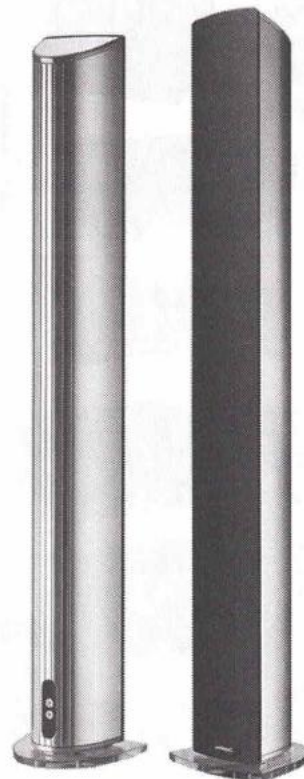

stereo shop
audio/video interiors

The Stereo Shop, for 46 years, is Central Connecticut's custom audio/video specialist. The systems on this page provide the absolute best sound and value at their price. They sound excellent and offer superior build quality and reliability. We have these systems on display for your evaluation and we are sure you will agree they provide first-class entertainment. At The Stereo Shop, there is no substitute for quality, knowledge and experience. **Please call us at 523-7250 for information anytime.**

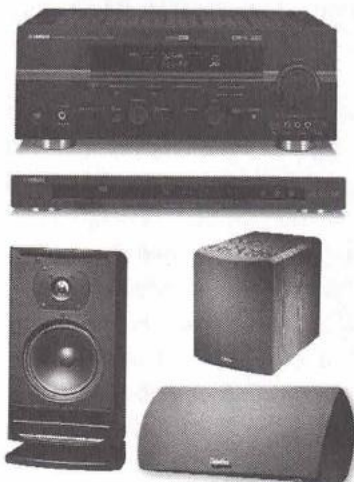

Good

Yamaha RX-V650 Digital Surround Receiver

Yamaha DVD-S550 Single Disc DVD

Definitive Technology Pro Cinema 100 Front, Center, Rear Speakers

Definitive Technology Pro Sub 100 250 watt Subwoofer

> **SPECIAL SYSTEM PRICE \$1,995.00**

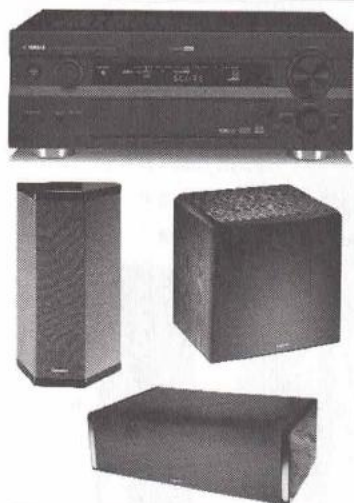

Better

Yamaha RX-V1500 Digital Surround Receiver

Definitive Technology BP-7004 Power Front Speakers

Definitive Technology L/C/R 2300 Powered Center Speakers

Definitive Technology BP2X Bipolar Rear Speakers

Definitive Technology PF15 15" Subwoofer

> **SPECIAL SYSTEM PRICE \$3,995.00**



Best

Rotel RSP-1068 Dual Zone Preamp/Processor

Rotel RMB-1075 100 watts/5 Power Amplifier

B&W 703 Front Speakers

B&W HTM7 Center Speaker

B&W 705 Rear Speakers

B&W ASW 675 Powered Subwoofer

> **SPECIAL SYSTEM PRICE \$8,499.00**

STEREO SHOP WINTER SALE

Save up to 70% on selected pre-owned, demo and new components. Each component is completely reconditioned and comes with twice the normal guarantee - each is guaranteed for six months! These are truly great values, providing excellent performance for the price. Our service department certifies that each meets the original factory specifications.

Manufacturer	Model	New	Used	Sale	Manufacturer	Model	New	Used	Sale
Receivers					DVD Karaoke				
McIntosh	MAC-1700 (45 watts per channel-tube tuner)	649	795	695	Pioneer	DVD-V555 (New In Box)	600	500	379
KLH	Model 52 (33 watts per channel - 70s classic)	320	250	195	Cassette players				
McIntosh	MAC-4300V (100 watts per channel)	2995	2795	2495	Tandberg	TCD-320 (One of the best cassette decks ever made!)	650	525	279
Audio/Video Receivers					Marantz	SD-4050 Dual Well	295	219	179
Yamaha	RX-V490 (Dolby Pro Logic, DSP) no remote			195	Nakamichi	RX-202 Auto Reverse	800	595	495
Power Amplifiers					Tandberg	TCD-310 MK II	600	300	249
McIntosh	MC-2105 (105 watts per channel with meters)	800	1300	1195	Nakamichi	CR-2A great sounding deck	495	495	395
McIntosh	MC-2150 (150 watts per channel) silver, power guard	1925	1650	1495	Nakamichi	500	550	695	595
McIntosh	MC-7205 (5 channel x 200 wpc with meters)	4500	3750	3495	Nakamichi	700 Beautiful silver face	850	795	695
McIntosh	MC-300 (300 wpc with meters) power guard	4000	3250	2995	Nakamichi	582 (Audiophile deck-Rare)	995	1195	495
McIntosh	MC-2505 (50 watts per channel with meters)	550	895	795	Loudspeakers				
Adcom	GFA-7000 (130 wpc - THX home theater amp)	1300	900	795	McIntosh	XR-3 4-way with 10" woofer	850	800	695 pr
C-Johnson	MF-2250 DEMO (125 watts per channel)	2295		1850	Definitive Tech.	BP-2006 (Demo)	1200		995 pr
Integrated Amplifiers					Definitive Tech.	BP-10	1000		595 pr
McIntosh	MA-5100 (45 watts per channel- solid state)	450	695	595	Theil	1.5 Cherry (Demo)	2600	1950	1495 pr
McIntosh	MA-6100 (70 watts per channel- solid state)	700	1295	1195	B&W	808 Dual 12" Woofers	8000	4895	4295 pr
McIntosh	MA-230 (30 wpc -MAC Collectors Item)	349	1295	1195	McIntosh	XD-717 (Tower speaker, 12" woofer)	1600	1450	1195 pr
Roksan	Caspian (70 watts per channel)	1600	895	795	McIntosh	XRT- 18 Black	5400	3500	3000 pr
Preamplifiers					B&W	P-4 (Slim Tower -Black)	1200	950	695 pr
McIntosh	C-27 (MAC Classic- Solid State)	750	800	695	Theil	Power Plane (New In Box)	2400	2150	1495 pr
McIntosh	C-24	250	495	395	McIntosh	HT-4 center channel	1100	849	750 ea
McIntosh	C-39 (Dolby Pro Logic, 2 Zone)	4000	1795	1295	McIntosh	HT-5 center channel	1100	995	900 ea
McIntosh	C-26 (Rugged MAC Collectors Item- Solid State)	449	649	549	B&W	DM-602 S1 Light oak	600	400	350 pr
McIntosh	C-11	210	1995	1795	Subwoofers				
McIntosh	C-35	1995	1495	1295	Velodyne	HGS18BG (18" woofer, Demo)	3500	3000	2795
McIntosh	C-42	3700	3250	2995	Matched Component Sets				
McIntosh	C-504	1090	1090	995	McIntosh	MC2105/ MX-113/ MCD7005/ XD717 Loudspeakers			4295
McIntosh	C-31V	1895	1295	1195	Adcom	GTP-500 preamp/GFA-555 (200wpc) power amplifier			995
Adcom	GTP-506 multi zone preamp	1000	750	595	Aragon	28K-MKII preamp/2002 amplifier (Demo)			1995
Conrad Johnson	Premier 17LS	4495	2795	2495	ADS	C-3/ CD-3/ A-2/ T-2			750
Conrad Johnson	Premier 17 LS (Demo)	4495	3250	2995	Home Theater Equipment				
Conrad Johnson	PV-14 L (Tube Design- Demo)	1995	1495	1395	McIntosh	MVP-831 DVD, Incredible CD playback!	2750	1400	1295
Preamp/Tuners					McIntosh	MVP-841 DVD, Incredible CD playback!	3000	1995	1795
McIntosh	MX-134 (Demo)	7100	Demo	4995	Yamaha	CX-1 5 Disc reference DVD player	1195	895	495
McIntosh	MX-130 Dual Zone Dolby Pro Logic	4800	1995	1795	Fosgate	3604 Digital Space Matrix	800		99
McIntosh	MX-110 (tube, No FM)	400	1295	695	Fosgate	3602 Digital Space Matrix	800	149	99
McIntosh	MX-113 (Solid State-FM stereo- Collector's Item)	1100	1200	895	McIntosh	MX-134 (Dolby Digital DTS 2 Zone -demo)	7100	Demo	4995
AM-FM Tuners					McIntosh	MX-130 Dual Zone Dolby Pro	4800	1995	1795
McIntosh	MR-67 (Tube Tuner)	300	1000	895	McIntosh	C-39	4000	1795	1195
McIntosh	MR-65B (Tube Tuner- Collector's piece)	330	650	595	Pioneer Elite	CLD-91 Laser Disc player	2000	1195	795
McIntosh	MR-73 (Solid State- Classic MAC)	550	950	795	Denon	DVD- 5000	2500	1195	995
McIntosh	MR-7082 (Analog Tuner w/ Digital Readout)	1580	1295	995	Turntables				
McIntosh	MR-510	1700	995	895	Dual				149
Luxman	T-115 (Hardwood Case)	500	349	295	Garrard Lab	82 (Fully Automatic-78 speed0	199	249	199
Yamaha	T-80 (Digital fine Tuning)	395	395	349	Miscellaneous				
Mitsubishi	DA-F10 (Audiophile tuner)	425	395	349	McIntosh	MI-3	220	1195	995
Compact Disc Players					McIntosh	R-603 Panel Adapter for CR7 and CR8 (3 in stock)			99.95
McIntosh	MCD-7009 (High-End Single Disc)	2750	1995	1495	McIntosh	R-626 Tape Recorder Interface			79.95
McIntosh	MCD-7008 (Changer, 7-disc magazine)	2220	1700	1195	McIntosh	S3-200 New construction bracket for WS200 (3 pair)			19.95
McIntosh	MVP-831 with Video	2750	1400	1295	McIntosh	CR-8			249.00
McIntosh	MVP-841 with Video	3000	1995	1795	Audio Control	Phase Coupled Processor			179.00
Onkyo	DX-3500	420	125	95	Don't forget to visit us on the world wide web at				
Arcam	CD-92	1899	1600	1295	www.thestereoshop.com				
Arcam	DV-88 DVD-CD player	1599	1295	995					
Arcam	DV-88 DVD-CD player (Progressive Scan)	2100	1695	1295					
Arcam	FMJ CD-23 DEMO	2500	2200	1795					

QUALITY • KNOWLEDGE • EXPERIENCE



Tivoli Model One – This beautifully styled small mono table radio can fill even a large room with natural sound. Harken back to the time when products were honestly, tastefully and efficiently designed! No superfluous buttons, digital displays, or other bells and whistles detract from sheer listening enjoyment. The Model One uses a state of the art, discrete-component FM tuner resulting in

better reception with increased clarity. With its precise, easy to use analog tuning you can enjoy the maximum number of listenable stations. **\$99.00**

Tivoli Model Two – Similar to the Model One, but with an additional Companion Speaker, this is a stereo radio. You can separate the two speakers up to fifteen feet apart for great sounding stereo. You can add the Model CD and Model Subwoofer for a fantastic mini-system! **\$159.00**



Tivoli Model Three Clock Radio – This is a great-sounding clock radio, with the same simple features and beautiful wood finish as the other Tivoli radios. It includes a 20-minute sleep timer and snooze button. It can be the heart of a mini-system by adding a companion speaker, Model CD and Model Subwoofer! **\$199.00**



stereo shop

audio/video interiors

Newsletter of The Stereo Shop, Inc.

505 Farmington Avenue, Hartford, CT 06105
Telephone (860) 523-7250
www.thestereoshop.com

Store Hours:

Tues.-Wed.-Fri. 9-6
Thursday 9-7:30
Saturday 9-5

Closed Monday

Available Exclusively at the

STEREO SHOP

Arcam, McIntosh,
Conrad-Johnson, B&W,
Fujitsu, Runco,
Definitive Technology,
Tributaries, Canton

Also on display for your evaluation

Yamaha, Rotel
Velodyne, Mitsubishi,
Audioquest, Ortofon, Grado,
SpeakerCraft, Salamander